

TWSMA-6dB-12G-SMA(M,F)

Coaxial Fixed Attenuator

Typical Applications

- Fixed Wireless & Microwave Radio below 12.4 GHz
- Military, Space & Satellite Communications
- Test and Measurement Equipment

Main Features

- Low VSWR
- Flatness Attenuation Value
- SMA Connectorized
- RoHs Compliant
- Custom designs available for other special attenuation value & accuracy



Electrical Specifications

Parameter	Unit	Specification
Frequency Range	GHz	DC – 12.4
Attenuation Value	dB	6 typ.
Accuracy	dB	± 0.8
VSWR Input/Output		1.3 : 1 max
Average Power	W	2 max CW at 25°C
Peak Power	W	500 max (5µs pulse width with 0.4% duty cycle)
In/Out Impedance	Ohm	50 typ.

Environment

Parameter	Unit	Specification
Operating Temperature	°C	-55°C to +125°C

Products and Product Information are Subject to Change Without Notice

TWSMA-6dB-12G-SMA(M,F)

Coaxial Fixed Attenuator

Mechanical Specifications

Parameter	Unit	Specification
RF connectors		SMA – Female / SMA – Male
RF connectors material		Brass Gold Plated
Male Pin		Brass Gold Plated
Female pin		Beryllium Copper Gold Plated
Housing		Brass Gold Plated
Dimensions	mm	Diameter=10, L=30
Weight	g	10

Outline drawing

All dimensions in mm

Dimensions Tolerance $\pm 2\%$

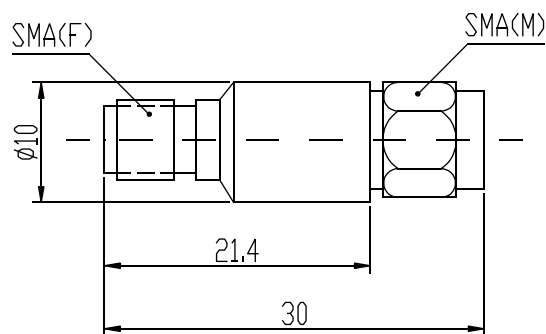

Products and Product Information are Subject to Change Without Notice